



Features

- . Compliance to EN IEC 61000-3-2 (<25W) standard
- . IP20
- . Protections: Short circuit / Overload / Over voltage
- . Compliance to worldwide safety regulations for lighting
- . 3 years warranty



Description :

SY9980B is an indoor ultra-thin constant voltage LED power supply. The input voltage range is 180-264Vac, with the high efficiency up to 83%, working in the temperature range of -20°C~+45°C . It has ultra-high power factor, low THD, low standby power consumption, full protection function, which not only greatly improves the reliability of the product, but also ensures the life cycle of product. The product completely in accordance with EN IEC 61000-3-2 THD standard. This series is designed for LED lighting, suitable for indoor lighting fixture.

Model

Model	Rated output voltage	Rated output current	Max. output power	Output voltage tolerance	Total harmonic distortion (Typ.)	Power factor (Typ.)	Efficiency (Typ.)
SY9980B	12V	0-0.67A	8W	±5%	53%	0.80	81%

Remark: All parameters NOT specially mentioned are measured at 230VAC input, full load and 25 °C of ambient temperature

Input

Parameter	Min. value	Typical value	Max. value	Note
Rated input voltage	200 Vac		240Vac	The derating curve is shown in the figure
Input voltage	180 Vac		264Vac	
Input frequency	47Hz		63Hz	
Max. Input current			--	110Vac , Full Load
			0.085A	180Vac , Full Load
Input inrush current			60A	230Vac/50Hz , Cold Start
Power factor	0.75	0.80		230Vac , Full Load
Total harmonic input		53%	58%	230Vac , Full Load
Leakage current			0.7mA	230Vac/50Hz , Full Load
Stand-by power consumption		0.15W	0.5W	230Vac/50Hz , No Load

Output

Parameter	SY9980B	Note
Rated output voltage	12VDC	Max. Output power should compliance to $P_o = V_o \cdot I_o = 8W$
The min. output voltage (CC mode)	--	
Rated output current	0-0.67A	
Output current ADJ. range	--	
Rated output power	8W	
Rated output efficiency	81%	230Vac
Output current tolerance	--	
Output voltage ripple (PK-PK)	4%	Full load (Test under 20M bandwidth)
Output current ripple (PK-PK)	--	
Rise time	100mS	230Vac
Startup time	400mS	230Vac
Line regulation	±1%	Full load
Load regulation	±2%	

Characteristic curve

Fig. 1 Output load-Temperature curve

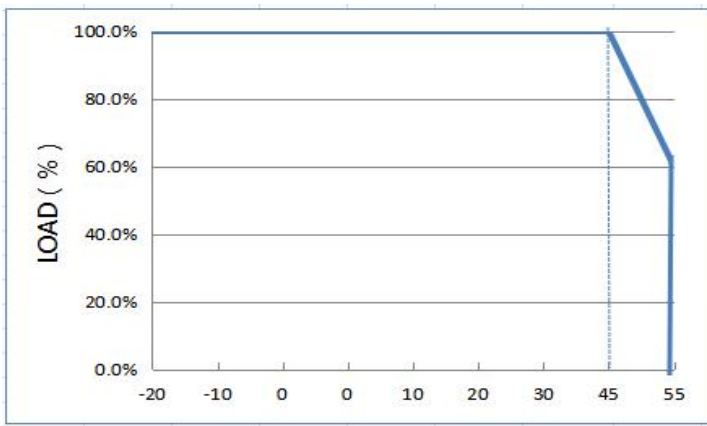

Fig. 2 Static characteristic curve

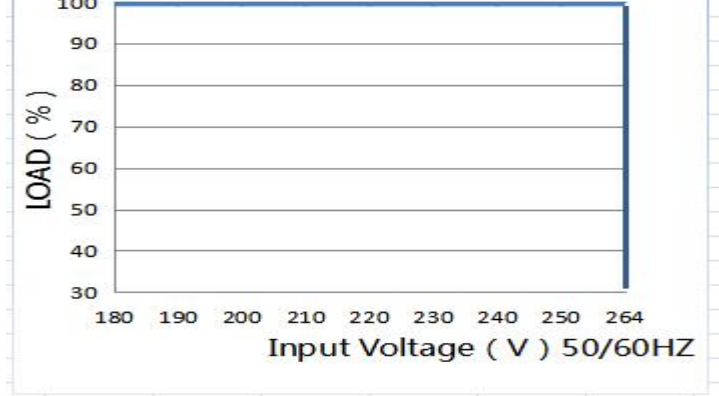

Fig. 3 I-V curve

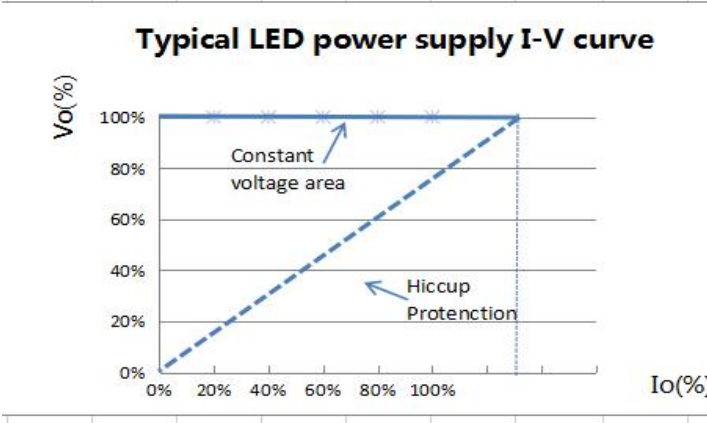

Fig. 4 Power factor characteristic curve

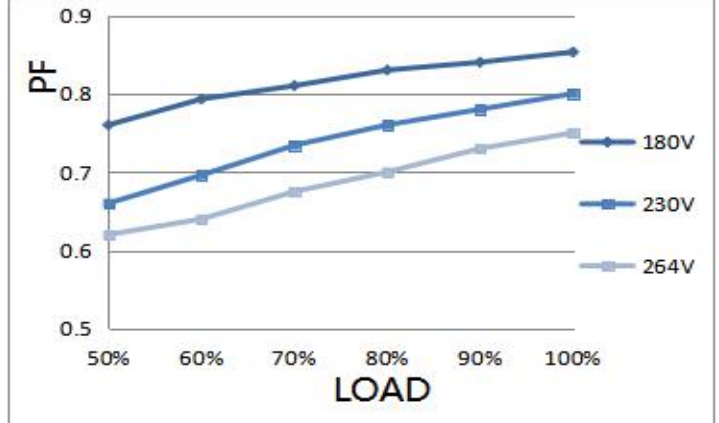

Fig.5 Total harmonic distortion curve (THD)

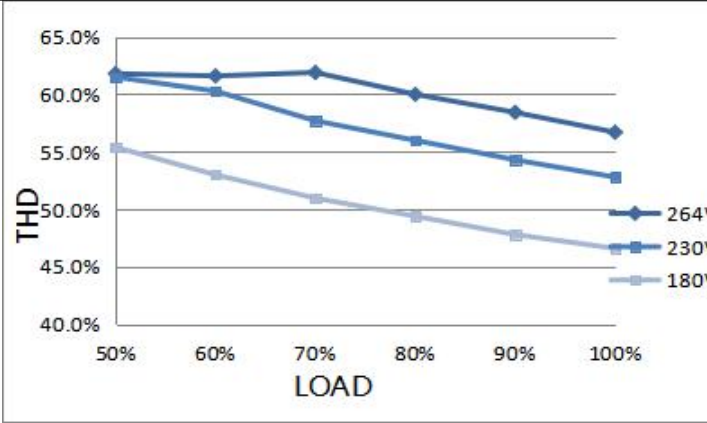
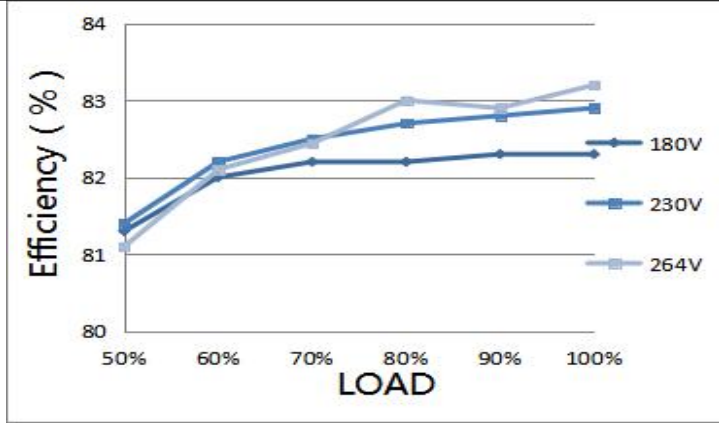

Fig.6 Efficiency-Load curve



Protection

Parameter		Conditions	Note
Protection	Over load	1.4 times rated load	Recover automatically when cancel overload
	Short circuit	Short circuit power $\leq 0.5W$	Hiccup mode, auto-recovery after short circuit removed
	Over voltage	1.5 times of rated output voltage	auto-recovery after over voltage removed
	Over temperature	--	--

Environment Requirement

Parameter	Min.	Typ.	Max.	Note
Working temp.	-20°C	25°C	+45°C	See Fig.2
Storage temp.	-40°C	25°C	+85°C	
Working humidity	10%RH		90%RH	
Storage humidity	5%RH		95%RH	
IP grade		IP20	IP20	
Cooling mode	Natural cooling			

Remark: All parameters NOT specially mentioned are typical values measured at 25 °C of ambient temperature

Safety&EMC Standard

Certificate		Safety standards	Certification	Note
UL/CUL		UL8750	---	
TUV		EN61347-1:2015 EN 61347-2-13:2014+A1 EN62493:2015	√	
SAA		AS/NZS 61347.2.13		
CCC		GB 19510.14-2009		
CE		EN 61347-2-13:2014 +A1 EN61347-1:2015	√	
Safety test		Technical indexes	Note	
Dielectric strength	Input to output	3200Vac/5mA Max/60s	Reinforced insulation, no breakdown, no flashover	
	Primary to ground	1600Vac/5mA Max/60s	Basic insulation, no breakdown, no flashover	
	Secondary to ground	1000Vac/5mA Max/60s	Functional insulation, no breakdown, no flashover	
Insulation resistance	Input to output	≥10MΩ	Test voltage : 500Vdc	
Grounding resistance		≤0.1Ω	25A/1min	
Leakage current		≤0.75mA	277Vac	
EMI/EMS item		Standards	Basis	
Conduction CE		EN55015		
Radiation RE		EN55015		
Harmonics		EN IEC 61000-3-2	Class C	

Others

Parameters	Condition	Note
Lifetime	30000 hours	230Vac , Full load, case Temp. 75°C
MTBF	200,000 hours	230Vac , Full load, 25°C(MIL-HDBK-217F)
TC	75°C	
Warranty	3 years	TC : 75°C
Weight	SE8-12VL: 48g	

Mechanical Specification (Unit : mm)

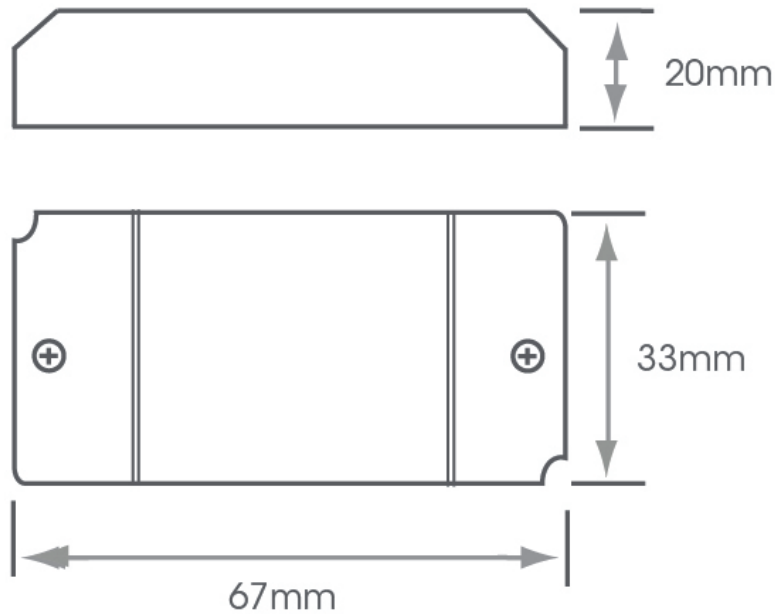

Remark :

AC input cable	Terminal , H03VVH2-F 2×0.75mm ²
DC output cable	Terminal , H03VVH2-F 2×0.75mm ²